

brands you trust.



Industrial Diaphragm Valves



DIAPHRAGM VALVES HISTORY

Pioneers in Diaphragm Valve Technology

P. K. Saunders invented the original diaphragm valve in 1928. Since then, we have developed our range through innovative design by using the latest materials technology and our extensive Polymers technology knowhow. As a result, Saunders diaphragm valves have gained an excellent reputation for versatility and reliability establishing a presence in every process industry sector.



Today, Saunders® is an international leader in the design, development and manufacturing of diaphragm valves. As part of Crane Co, a diversified global manufacturer of engineered industrial products, Saunders has a strong worldwide presence via dedicated sales companies and distribution partners.

History of Innovation

Saunders® has led the way in the development of the diaphragm valve to meet the ever increasing demands of industrial applications. These innovations have included the introduction of:

- First PTFE diaphragms
- First supplier of glass and fluorocarbon linings
- First non-bonded PTFE diaphragm
- First compact pneumatic actuators
- First 3 layer diaphragm for corrosive-gas applications
- First modified PTFE diaphragm
- Introduction of the XA diaphragm (resistant to both chemical and abrasive attack)

Key Diaphragm Valve Features

- 1 Full closure even with solids present
- 2 Only two wetted parts
- 3 Wide range of linings and diaphragms to suit most applications

A Continuing Story of Success

Millions in service

Saunders diaphragm valves are used in every process industry. Millions of Saunders diaphragm valves are currently installed in process plants around the world and they are renowned for versatility and reliability.

Dependable operation

Engineers know they can trust Saunders Valves. They set the industry standard for dependable, consistent operation, even in the most adverse conditions with years of trouble-free performance.

Customer Service

Customers know they can depend on Saunders for after sales service and technical support from one of our many locally based sales associates and distribution partners.

The Science Inside

Saunders proudly develops and manufactures its polymer compounds, with more than 80 years of polymer technology. It is "The Science Inside™" our valves which sets us apart.

Global Compliance

Saunders diaphragm valves are fully compliant to all global standards.



Key Diaphragm Valve Benefits

- 1 Leak tight* by design
- 2 Minimal maintenance
- 3 Better resistance to corrosion/abrasion and longer life

*in accordance with standards MSS SP-88 and BS EN 12266-1

DIAPHRAGM VALVES KEY PRODUCTS

A Type Weir Design for Corrosive Media and Utilities

- Versatile and extensively used in industrial applications
- Can handle up to 15% solids (depending on process conditions)
- Perfect valve for on/off or control applications on corrosive processes

KB & K Type Straight Through Designs for Solids Handling

- Smooth, straight-through design
- High flow capacity
- Can handle highly abrasive fluids

WFB For Marine and Fire Applications

- Weir type valve for fire fighting, tank cleaning or wash down on land or sea
- Guaranteed operation even after years of being static
- Fire tested diaphragm

NX Check Valve

- Low pressure and vacuum duties
- Unidirectional full flow design
- Corrosion resistant linings

Actuation - Modular or Compact Actuators

- Different actuator types that cover up to DN250
- Wide range of line and operating pressure options
- Conceived to withstand the most adverse conditions

In-house Manufacture of All Diaphragms

- Vulcanized layers with high strength woven reinforcement in elastomer-based diaphragms
- Range of PTFE-type diaphragms for critical applications
- Innovative compounding based on extensive polymer knowledge



"We are pleased to inform that we are using Saunders in our Runcorn chlor-alkali and chlorine derivatives plants. We are very satisfied with the product's reliability, low maintenance costs and with the quality of the technical service. We hope to get the same support in all our future supplies/requirements"
INEOS ChlorVinyls (UK)

"We specified Saunders WFB 65mm nominal bore fire-mains hydrant valves for our ferries and cruise liners. Significant factors behind this choice are the excellent reliability and the low maintenance costs."
P&O Cruises (UK) Ltd

DIAPHRAGM VALVES WHY DIAPHRAGM VALVES?

1 Corrosion Resistance

Saunders lined valves are the first choice for corrosion resistance applications. We offer an extensive range of linings and diaphragms to suit most applications. This wide choice of body lining and diaphragm materials provides an effective and economical solution to your application by avoiding the use of exotic alloys. Our extensive range of valve options include elastomer and fluoropolymer linings, designed especially to combat corrosion.

3 Leak Tight*

On pressure and vacuum services, Saunders diaphragm valves operate and close ***100% leak tight, in accordance with standards MSS SP-88 and BS EN 12266-1**, even after thousands of operations, reducing processing and handling costs, by eliminating emissions normally associated with other valve types.

5 Easy Maintenance

Three part design allows maintenance and actuator retrofitting without removing the valve body from the pipeline. Overall this results in lower cost of ownership compared to other valve types.



7 Cost Effective

The body remains in the pipeline during service and it takes only minutes to change a diaphragm, resulting in significant down time savings at site.

2 Abrasion Resistance

Saunders polymer technology provides superior abrasion resistance. The KB straight through valve will handle up to 100% solids and with the use of a soft rubber diaphragm, will still give tight shut-off, **in accordance with standards MSS SP-88 and BS EN 12266-1**

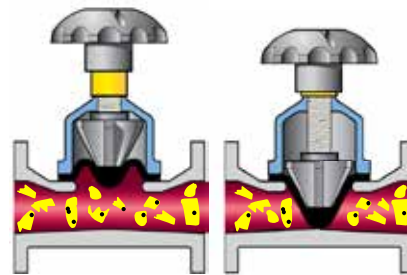

4 Operating mechanism not in contact with line media

All working parts of the valves are isolated from the line media and positive closure is obtained even on frequent cycling or with entrained particulates in the line unlike other valve types.

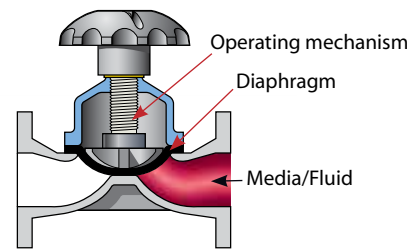

6 Suitable for Control

Throttling and control characteristics are enhanced by a streamlined flow path that is cavity free and provides excellent flow control capabilities.

8 Valve usable in any Position Self Drain

The Saunders valve can be installed in any position without affecting its operation. However, we recommend installation to be at least 6 times the pipe diameter from bend or pump (10 times the pipe diameter if the valve is used for control).

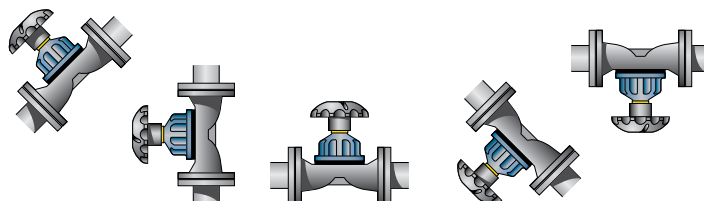

DIAPHRAGM VALVES COMPARISON

						
	Diaphragm	Ball	Butterfly	Globe	Gate	Lubricated Plug
Leak tight* shut-off against gases, liquids and solids	Green	Yellow	Yellow	Yellow	Yellow	Yellow
Resistance to abrasion and erosion	Green	Yellow	Yellow	Red	Yellow	Yellow
Wide choice of materials to match service conditions	Green	Green	Green	Yellow	Yellow	Yellow
Non-turbulent friction loss	Green	Green	Yellow	Red	Green	Green
Low fluid friction loss	Green	Green	Yellow	Red	Green	Green
Resistance to corrosion	Green	Green	Green	Yellow	Yellow	Yellow
Vacuum capability	Green	Green	Yellow	Yellow	Red	Yellow
Maintenance — in-line servicing, low cost spares	Green	Yellow	Yellow	Red	Red	Yellow
High purity	Green	Yellow	Yellow	Red	Red	Red
Control applications	Green	Yellow	Yellow	Green	Red	Yellow
On/off applications	Green	Green	Green	Yellow	Yellow	Yellow
Temperature range	Yellow	Green	Green	Green	Green	Yellow
Pressure range	Yellow	Green	Green	Green	Green	Green
Weight/size ratio	Yellow	Yellow	Green	Yellow	Yellow	Yellow

Suitable **Not Suitable**

Saunders offers a comprehensive range of diaphragm valves for any industry. They encompass the full spectrum of corrosive and abrasive applications that require reliable valve operation. Easily maintained to ensure many years of trouble free operations, Saunders diaphragm valves have become a standard in industries such as chemical production, mining, water treatment, fertilizers and marine to name a few.

**in accordance with standards MSS SP-88 and BS EN 12266-1*

DIAPHRAGM VALVES APPLICATIONS

CORROSIVE

Corrosion is estimated to cost worldwide industry more than 300 billion dollars every year. Saunders lined diaphragm valves are the best option to handle these media.

- Chloro-Alkali
- Sulphuric Acid
- Hydrochloric Acid
- Nitric Acid
- Aromatics
- Effluent Treatment
- Potable Water
- Pulp and Paper
- Organics
- Toxic Fluids
- Iron and Steel
- Fine Chemicals

ABRASIVE

Saunders KB valves are ideally designed for applications requiring a combination of corrosion and abrasion resistance, reliability and long service life.

- Fertilizer
- Titanium Dioxide
- Phosphate
- Copper Mining
- Gold Mining
- Sand
- Coal Slurry
- FGD
- Cement
- Ceramics
- Sewage
- Sugar

GENERAL APPLICATIONS

The best solution for a wide range of water, air and gas applications.

- Water demineralization
- Marine
- Vegetable Oils
- Paints
- Fire Fighting
- Tanning
- Oil Production
- Automotive
- Gaseous effluents
- Fuels
- Food & Beverage
- Waste Water
- HVAC
- Compressed air and gases

Type	Applications	Body/Lining	Diaphragm
C	Strong Acids	ETFE, PVDF, PFA, Glass ⁽¹⁾	PTFE-based diaphragms
C	Fine Chemicals and Chlor-alkali	Wide range of Rubbers, Glass ⁽²⁾ or Plastic linings	Fluoroelastomer, Chlorosulphonated polyethylene or PTFE-based diaphragm
C / A	Mineral processing	Butyl, Soft rubber	Butyl, Natural rubber and the Ultimate XA ⁽³⁾
C / A	Gypsum (FGD)	Butyl	Butyl & Ultimate XA
C / A	Titanium dioxide	Glass, Butyl, Soft rubber	Butyl, Natural rubber
C / A	Fertilizers	Butyl, Polychloroprene	Butyl, Polychloroprene and The Ultimate XA ⁽³⁾
C / A	Paper Pulp	Glass, Halar, Butyl	EPM, Butyl, Polychloroprene and the Ultimate XA ⁽³⁾
A	China clay	Butyl, Soft rubber	Natural rubber, Polychloroprene
G	Water demineralization, desalination, and sewage treatments units	Hard rubber, soft rubber, Butyl	EPM, Butyl, Polychloroprene, Butadiene Acrylonitrile
G	Marine and fire fighting ⁽⁴⁾	SG Iron and Gunmetal	Chlorosulphonated polyethylene (Kevlar reinforced)
G	HVAC and Utilities (Air, water and gas lines) ⁽⁵⁾	Screwed/Flanged unlined valves in iron, stainless steel or gun metal	EPM, Butyl, Polychloroprene

C = Corrosive, **A** = Abrasive, **G** = General Applications

⁽¹⁾ Glass is not suitable for applications hydrofluoric acid and applications with high thermal amplitude or thermal cycling

⁽²⁾ Chemical etching may occur when in contact with hydrofluoric acid and alkali. Please contact Saunders for precise recommendations.

⁽³⁾ The Ultimate XA Diaphragm was specially developed for highly corrosive and abrasive applications.

⁽⁴⁾ Used primarily as water hydrant valves.

⁽⁵⁾ Used in copper or stainless steel piping in water, oxygen and other gases.

DIAPHRAGM VALVES POLYMER SCIENCE

At Saunders we apply rigorous quality control measures at every manufacturing step of our polymer materials. For many years we have developed our expertise and accumulated experience in the production of our own **diaphragms** and valve **linings**. As a result, our valves can handle the most challenging fluids with total security. The name Saunders is synonymous with innovation, continuous product development and high standards of quality control.



A type, 300 grade diaphragm



PTFE diaphragm with 300 grade backing



KB type, AA grade diaphragm



214K diaphragm for high performance in Chlorine applications

Fixing Features



Rubber Diaphragm
A & KB/K type screw fixing



PTFE diaphragms have
Bayonet fixing

BEST MATERIALS

STRINGENT QUALITY CONTROLS

RELIABILITY, LONG LIFE & SIMPLIFIED MAINTENANCE

Diaphragm Construction



- Appropriate choice of the finest raw materials and fabric reinforcements.
- Diaphragms constructed with multi-layers of rubber and reinforcement for maximum performance and durability.
- Studs attached with bonding adhesive and mechanical anchorage.
- Dual sealing ribs (across the weir and around the diaphragm periphery) for enhanced leak tight sealing capabilities and lower closure torque.
- Optimised thickness of diaphragms for superior flexing properties.

PTFE Diaphragm



Two-piece diaphragm construction - PTFE face, with reinforced rubber backing - to increase pressure rating and durability.

DIAPHRAGM VALVES CERTIFICATES AND DATASHEETS

Saunders® Data Sheets

CDs are available for fast and accurate detailed information on the industrial valve range Saunders® has to offer. Contact your local sales office or distributor for details on how to order your CD.

The electronic data manual contains over 100 individual technical data sheets to assist you with the selection of the valve.



Data Sheet Index and typical valve information

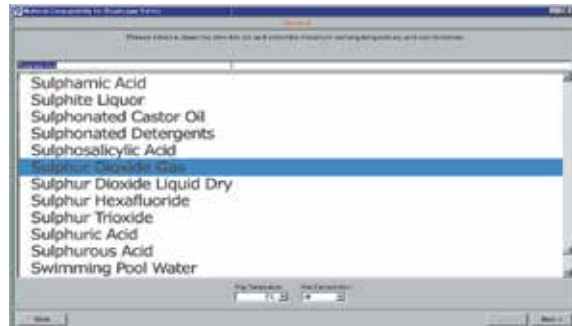

The Saunders Material Selection Database software is available which lists over 1,000 process chemicals.

QUALITY STATEMENTS AND APPROVALS

CERTIFIED QUALITY FROM CRANE FLOW SOLUTIONS

- Quality Management system registered to ISO 9001 standard in which our R & D and manufacturing process are optimized to maintain our product quality and service.
- Certified compliance to the European Pressure Equipment Directive 97/23/EC authorizing Crane Process Flow Technologies Ltd to CE mark relevant valve products.
- TUV-Merkblatt HPO Qualification for our product manufacturing and certification.
- International product approval from authorities such as Bureau Veritas, Lloyds.
- Polymer/Rubber materials certified as meeting the requirements of FDA, USP & WRAS.



QUALITY ASSURANCE APPROVALS

BS EN ISO 9001



TÜV AD-MERKBLATT
HPO



Compliance WITH
FDA Code 21
TNO CERTIFICATION 3A
cGMP USP 23

PRODUCT AND SYSTEM APPROVALS EXAMPLES

- ISO 9001
- PED 97/23/EC
- WRAS (Water Regulations Advisory Scheme)
- Lloyds Register of Shipping
- Bureau Veritas
- ATEX Directive (94/9/EC)
- Food & Drug Administration (FDA)
- United States Pharmacopeia (USP)
- Registro Italiano Navale (RINA)

DIAPHRAGM VALVES TYPE A (WEIR)

Original Saunders Design

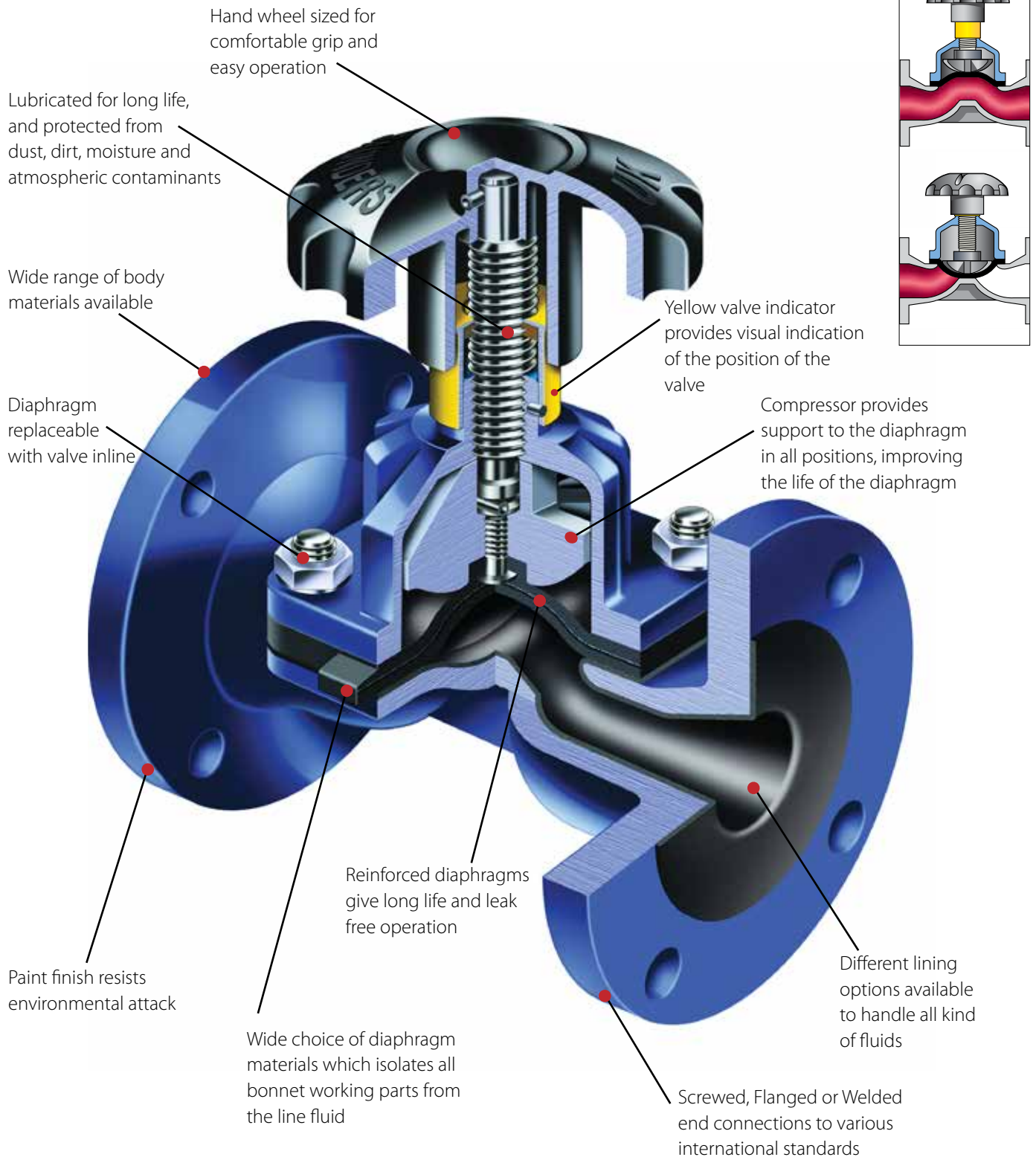

Saunders A type: the valve of choice to handle highly corrosive media

DIAPHRAGM VALVES TYPE A BODY

Body Lined and Unlined option

Our metal bodies provide simultaneous mechanical support for the lining and a protection for the lining against Ultraviolet (UV) attack. Saunders lining thicknesses range from 1 to 4.5mm (DN15-DN350) depending on lining material (glass 1 mm; rubber and plastic 3 to 4.5 mm).

Unlined Options				
Material	Connection	Standard	Size	Temperature
Cast Iron	Flanged	BS EN1561 GJL-250	(1/2" - 20") (DN15-DN500)	-10°C to 175°C
SG Iron ⁽²⁾	Screwed	BS EN1563 GJL-450-10	(1/4" - 2") (DN8-DN50)	-10°C to 175°C
	Flanged	BS EN1563 GJL-400-18	(1/2" - 14") (DN15-DN350)	
Cast Steel	Flanged	ASTM A216 WCB	(1/2" - 10") (DN15-DN250)	-30°C to 175°C
Gun Metal	Screwed	BS EN1982 CC491K-GS	(1/4" - 3") (DN8-DN80)	-30°C to 175°C
	Flanged	BS EN1982 CC492K-GS	(1/2" - 8") (DN15-DN200)	
Stainless Steel	Screwed	BS EN10283 1.4408 ⁽¹⁾	(1/4" - 3") (DN8-DN80)	-30°C to 175°C
	Flanged	BS EN10283 1.4408 ⁽¹⁾	(1/2" - 8") (DN15-DN200)	

⁽¹⁾ Replaces the standard BS3100 316C16

⁽²⁾ For some SG Iron grade (eg. GJS-400-18-LT), the lower temperature limit of -20°C.

(For more information on different materials, please contact Saunders)

Lined Options – Flanged only			
Lining	Body Material	Size	Temperature
PFA*	SG Iron	(1/2" - 6") (DN15-DN150)	-10°C to 175°C
ETFE*	SG Iron	(1/2" - 6") (DN15-DN150)	-10°C to 150°C
PVDF*	SG Iron	(3/4" - 6") (DN20-DN150)	-10°C to 130°C
PP*	SG Iron	(3/4" - 6") (DN20-DN150)	-10°C to 85°C

Glass**	Cast Iron	(1/2" - 10") (DN15-DN350)	5°C to 175°C
---------	-----------	------------------------------	--------------

Isobutylene Isoprene (Butyl)	Cast Iron	(3/4" - 14") (DN20-DN350)	-10°C to 110°C
	Cast Steel		-30°C to 110°C
	SG Iron*		-10°C to 110°C
Polychloroprene	Cast Iron	(3/4" - 14") (DN20-DN350)	-10°C to 105°C
	Cast Steel		-30°C to 105°C
Hard Rubber (Ebonite)	Cast Iron	(3/4" - 14") (DN20-DN350)	-10°C to 85°C
	Cast Steel		-30°C to 85°C
	SG Iron*		-10°C to 85°C
Soft Rubber	Cast Iron	(3/4" - 14") (DN20-DN350)	-10°C to 85°C
	Cast Steel		-30°C to 85°C
	SG Iron*		-10°C to 85°C

* Lower temperature limit is dependant on body substrate material.⁽²⁾

** Glass is not suitable for applications where thermal cycling occurs.

Note: For size and standards of the different combinations, please contact Saunders.

Plastic Lining

PFA Perfluoroalkoxy – Excellent suitability for concentrated strong acids at high temperature, aromatics, aliphatic and chlorinated solvents. (White colour)

ETFE Polyethylenetetrafluoethylene – Suitable for strong acids, salts in water, solvents at medium temperature. ETFE has the highest abrasion resistance of all the Fluorocarbon linings. (Red colour)

PP Polypropylene – Economic solution for mineral acids, salts in water, water and effluent treatment chemicals; (Light grey colour)

PVDF Polyvinylidene Fluoride – Suitable for mineral acids, salts in water, water and effluent treatment, additionally it is the best solution for Chlorine gas wet or in water. (Black colour)

Glass Lining

Used in many different applications, including strong acids or alkali. Very high corrosion and abrasion resistance within a wide range of temperature. Note that glass is not suitable for applications where thermal cycling occurs. (Blue colour)

Corrosion & Chemical Resistance

Rubber Lining

HRL Hard Rubber (Ebonite) – Used for salts in water, diluted acids, de-ionised water, plating solutions and potable water. HRL has better chemical resistance than SRL. (Black colour)

Butyl Isobutylene Isoprene – Great for corrosion & abrasion slurries, and acidic slurries. Additional applications are salts in water, diluted acids and alkali and lime. (Black colour)

Polychloroprene Polychloroprene – Perfect solution for a combination of abrasive slurries containing hydrocarbons, sludge oils and also sea water. (Black colour)

Soft Rubber Polyisoprene (Natural Rubber) – High abrasion resistance on powders, abrasive slurries, clays, coal dust, dry fertilizers, gypsum, as well as titanium dioxide and sewage. (red colour)

The temperature ranges above are given for general reference purposes only. Service conditions, such as media being handled and concentration of solids will determine the highest possible working temperature. Additionally, the performance of the valve will also depend on the diaphragm material.

DIAPHRAGM VALVES TYPE A DIAPHRAGM

How to identify your diaphragm

Manufacturing information

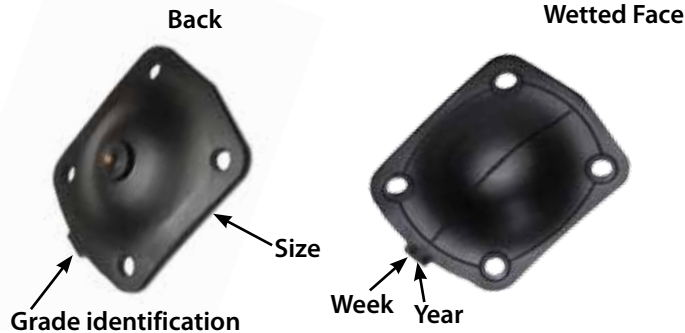

In the range of PTFE diaphragms, Saunders offers both moulded open and closed (214S/425) and moulded open (214/425) for your convenience. Moulded closed 214S has been specifically designed to reduce polymeric creep, increasing the sealing properties and life of the diaphragm



Moulded closed



Moulded open

PTFE Diaphragm

214/300 - Used in strong acids and alkali, salts in water at high temperature. Sulphuric acid is a good example with temperatures up to 110°C and concentrations up to 96%.

214/425 - Typical applications are strong acids. Alkalis and salts in water at high temperature. Constant steam is also another important application

214/226 - Strong acid, diluted chlorine, bromine solutions at low concentration

214S/425 - Strong acids, alkalis and salts in water at high temperature. Constant steam applications where the valve is mainly closed (diaphragm is moulded closed).

214K/425 - Three layer diaphragm with PTFE/PVDF/425, the best option for Chlorine, bromine gas and Chlorinated solutions.

Rubber Diaphragm

425 - Salts in water, acids and alkalis, ozone, water, intermittent steam. Great solution for food and beverages applications. FDA and USP approved⁽¹⁾

300 - Chemicals, diluted acids and alkalis, drinking water. Additional abrasive applications like phosphoric acid with low concentration. FDA, USP and WRAS approved⁽¹⁾.

237 - The best solution for sodium hypochlorite. Great with strong acids and low concentration chlorine gas. It is also oil resistant.

XA - Specifically designed for both abrasive and corrosive applications such as phosphoric acid, metal treatment, mining applications.

HT - Suitable for abrasive slurries containing hydrocarbons.

226 - Great solution for hydrogen at high temperature, concentrated acids, aromatics solvents, low concentrated chlorine solutions, ozone, unleaded petroleum.

C & CV - Lubricating oil, cutting oils, paraffin, animal vegetable oils, aviation's kerosene at low temperatures. CV is ideal for Vacuum applications, where oils are present, (compressed air, acetylene gas, LPG).

Q - Salts in water, diluted acids and alkalis and abrasive applications.

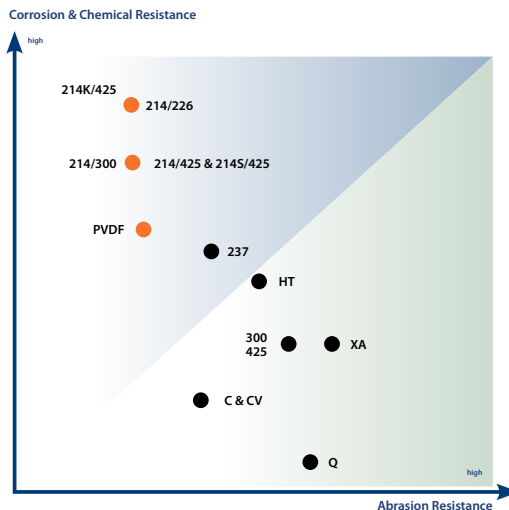

⁽¹⁾ FDA - Food & Drug Association

USP - United States Pharmacopeia

WRAS - Water Regulations Advisory Scheme

All rubber diaphragms have threaded brass fixings, except vacuum diaphragm (Cv, 300v), which have steel fixings. PTFE diaphragms have a stainless steel bayonet fixings

DIAPHRAGM VALVES TYPE A TOP WORKS

Top Works

Standard Range

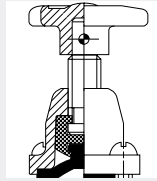

Rising Handwheel
Valves sizes: DN8 to DN10
(1/4" to 3/8")

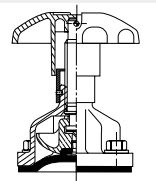

Cast iron bonnet with rising plastic handwheel
Valves sizes: DN15 to DN50
(1/2" to 2")

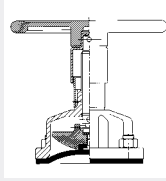

Cast iron bonnet with rising metal handwheel
Valves sizes: DN15 to DN150
(1/2" to 6")

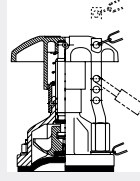

Rising Handwheel with indicator (simple padlocking)
Valves sizes: DN15 to DN150
(1/2" to 6")

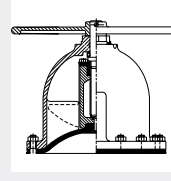

Standard Non-Rising Handwheel without indicator
Valves sizes: DN200 to DN350
(8" to 14")



Non-Rising Handwheel with indicator
Valves sizes: DN200 to DN350
(8" to 14")

High Performance

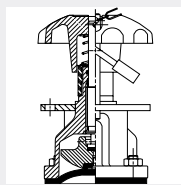

Fluoroelastomer sealed padlocking
Valves sizes: DN15 to DN150
(1/2" to 6")

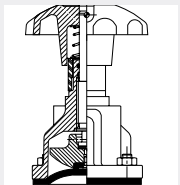

Fluoroelastomer sealed bonnet
Valves sizes: DN15 to DN150
(1/2" to 6")

Saunders Actuation

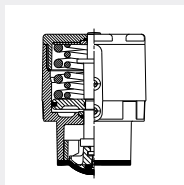

EC actuators (spring close/spring open/double acting)
Valve sizes DN8 to DN50
(1/4" to 2")

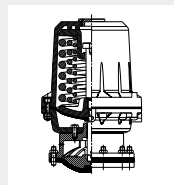

ECX actuators (spring close/spring open/double acting)
Valve sizes DN65 to DN150
(2 1/2" to 6")

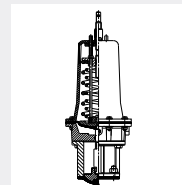

ESM/ES actuators (spring close/spring open/double acting)
Valve sizes DN15 to DN250
(1/2" to 10")

Note: Designs may vary across size range

For more details in actuation see pages 17-20

Manual Valves Working Pressure & Temperature

Maximum manual working pressures for A Type Saunders Diaphragm valves. For actuated valves, please refer to the appropriate datasheets

Bonnet pressure limits

Size (DN)	Pressure (bar)			
	Rubber (bar)		PTFE (bar)	
	Rising handwheel	Non-Rising handwheel	Rising handwheel	Non-Rising handwheel
8	16		10	
10	16		10	
15	16		10	
20	16		10	
25	16		10	
32	16		10	
40	16		10	
50	16		10	
65	10		10	
80	10		10	
100	10		10	
125	10		10	
150	10		7	
200		6		6
250		5		5
300		4		
350		3.5		

Note: For temperature rating, please refer to adjacent graphs.

All Saunders valves are pressure tested in accordance with BS EN12266-1 standard.

- Shell test: 1.15 times max rating working pressure
- Seat test: 1.1 times max rating working pressure

A Type Valve Body (Ductile Iron & Cast Iron) Temperature/Pressure Relationship

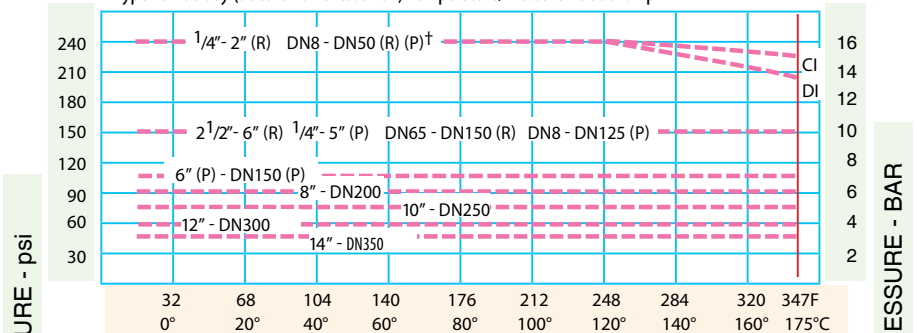

A Type Valve Body (Carbon Steel, St. Steel & Copper Alloys) Temperature/Pressure Relationship

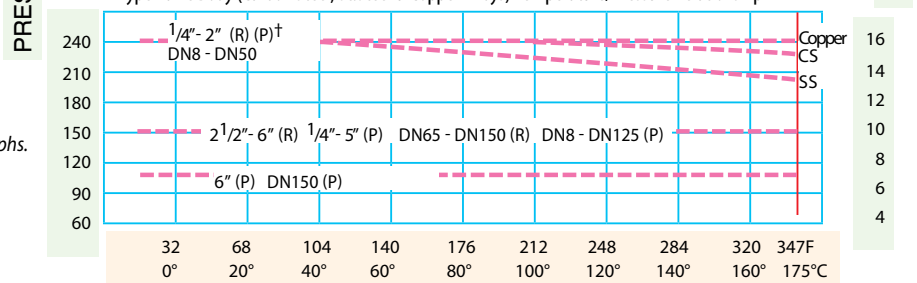

* When lined body is cast steel, minimum temperature is -22F-30°C. When DI Grade EN-GJS-400-18-LT is used, minimum temperature is -4F-20°C.

** Depends on body substrate material. † 214S Moulded closed version only.

DIAPHRAGM VALVES TYPE KB/K (STRAIGHT-THROUGH)

Saunders KB Design

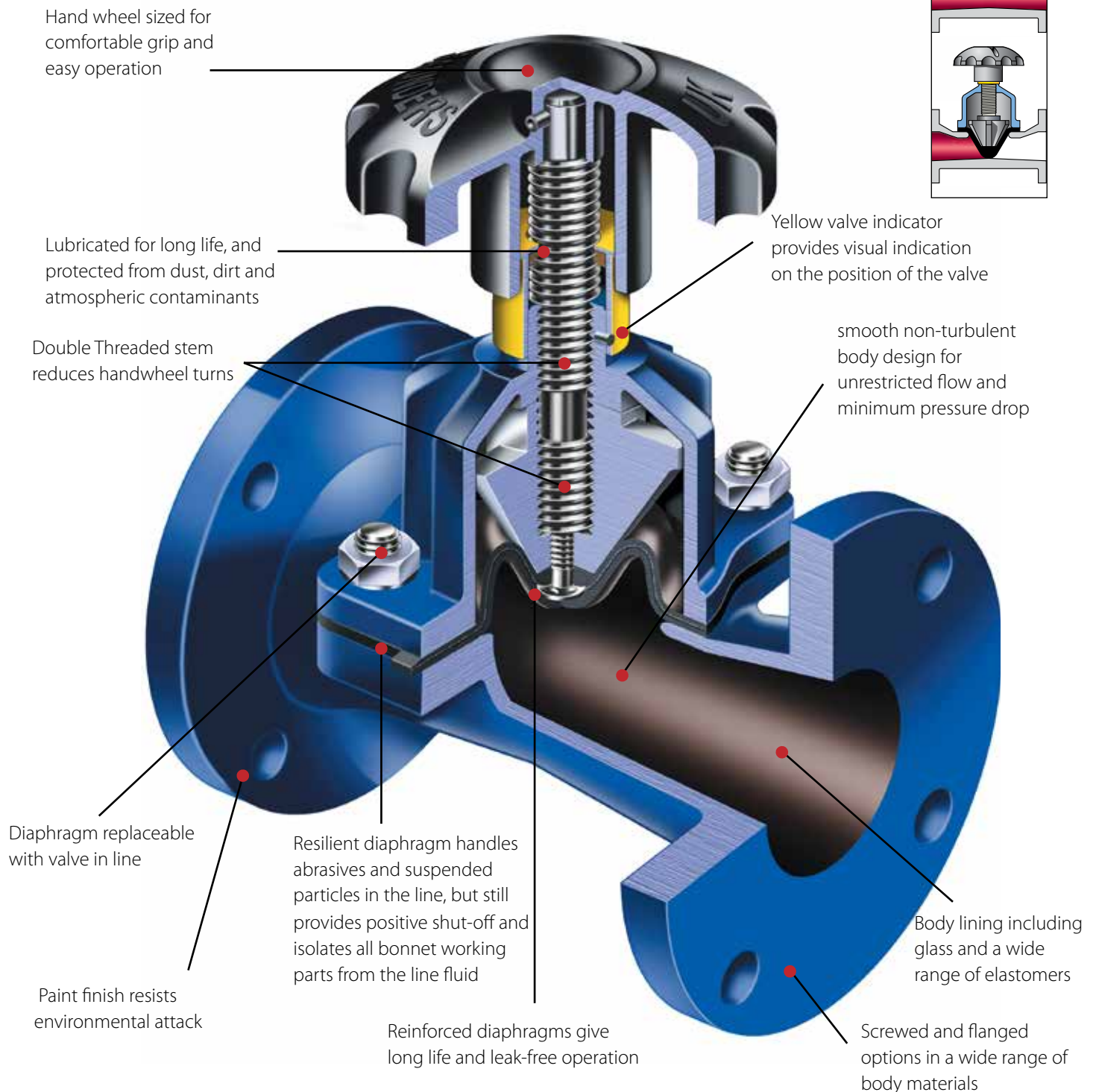

Saunders type K & KB high flow valves: the choice for corrosive slurry applications

DIAPHRAGM VALVES TYPE KB/K BODY

Body Lined and Unlined option

Saunders full bore KB type diaphragm valves, with their smooth non-turbulent body design, have proven to be outstanding in resisting the erosion effect of abrasive media, providing low pressure drop and high flow characteristics.

The flexible diaphragms ensure consistent leak tightness even when solids, powders and dry media are present. The wide range of lining materials make the valve suitable for many corrosive/abrasive applications (up to a maximum pressure of 10 bar.)

Unlined Options

Material	Connection	Standard	Size	Temperature
Cast Iron	Screwed	BS EN1561 GJL-250	(1/2" - 2") (DN15-DN50)	-10°C to 120°C
	Flanged		(1/2" - 14") (DN15-DN350)	
SG Iron ⁽²⁾	Screwed	BS EN1563 GJL-450-10	(1/4" - 2") (DN8-DN50)	-10°C to 175°C
	Flanged	BS EN1563 GJL-400-18	(1/2" - 14") (DN15-DN350)	
Gun Metal	Screwed	BS EN1982 CC491K-GS	(1/2" - 2") (DN15-DN50)	-30°C to 120°C
	Flanged	BS EN1982 CC492K-GS	(1/2" - 4") (DN15-DN100)	
Stainless Steel	Flanged	BS EN10283 1.4408 ⁽¹⁾	(1/2" - 10") (DN15-DN250)	-30°C to 120°C

⁽¹⁾ Replaces the standard BS3100 316C16

⁽²⁾ For some SG Iron grade (eg. GJS-400-18-LT), the lower temperature limit of -20°C. For more information on different materials, please contact Saunders.

Lining Options – Flanged only

Lining	Body Material	Size	Temperature
Glass**	Cast Iron	(1/2" - 8") (DN15-DN200)	-10°C to 120°C
Isobutylene Isoprene (Butyl)	Cast Iron	(1/2" - 14") (DN15-DN350)	-10°C to 110°C
	SG Iron*		
Polychloroprene	Cast Iron	(1/2" - 14") (DN15-DN350)	-10°C to 105°C
	Cast Steel		
Hard Rubber (Ebonite)	Cast Iron	(1/2" - 14") (DN15-DN350)	-10°C to 85°C
	SG Iron*		
Soft Rubber (Natural Rubber)	Cast Iron	(1/2" - 14") (DN15-DN350)	-10°C to 85°C
	SG Iron*		

* Lower temperature limit is dependant on body substrate material.⁽²⁾

** Glass is not suitable for applications where thermal cycling occurs.

Glass Lining

Used in many different applications, including strong acids, salts and halogenated gases. Superior corrosion and abrasion resistance within a wide range of temperatures and concentrations. (Blue colour)

Rubber Lining

HRL Hard rubber (Ebonite) — Used for salts in water, diluted acids, de-ionised water, plating solutions and potable water. HRL has better chemical resistance than SRL; (Black colour)

Rubber Lining

Butyl Isobutylene isoprene — Great for corrosive & abrasive slurries, and acidic slurries. Additional applications are salts in water, diluted acids and alkali and lime; (Black colour). WRAS Approved.

Polychloroprene Polychloroprene — Perfect solution for a combination of abrasive slurries containing hydrocarbons, sludge oils and also sea water. (Black colour)

Soft Rubber Polyisoprene — High abrasion resistance on powders, abrasive slurries, clays, coal dust, dry fertilizers, gypsum, as well as titanium dioxide and sewage. (Brown colour)

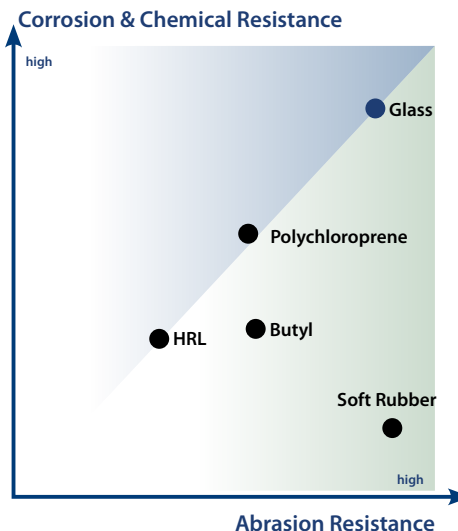

The temperature ranges above are given for general reference purposes only. Service conditions, such as media being handled and concentration of solids will determine the highest possible working temperature. Additionally, the performance of the valve will also depend on the diaphragm material.

Lining thickness depends on lining and size. Please contact us for full availability details

DIAPHRAGM VALVES TYPE KB/K DIAPHRAGM

Diaphragm

Many factors can accelerate the ageing effects of polymer compounds. Temperature and abrasion have a significant impact on the effect of chemicals on rubber compounds. At Saunders we are proud of our core competence, the in-house manufacture of Saunders diaphragms. Our know-how in polymer science assures the best range of diaphragms to suit the most challenging duties with total security. This explains why Saunders diaphragms are a synonym of longer life, reduced maintenance and higher plant operating efficiencies.

How to identify your diaphragm

Manufacturing information

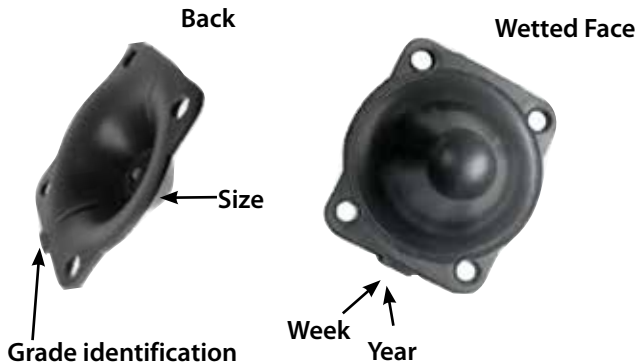

Energising ribs allow efficient shut-off in wide-bore applications



Fluoroelastomer

226 - Great solution for hydrogen at high temperature, concentrated acids, aromatics solvents, low concentrated chlorine solutions, ozone, unleaded petroleum.

300 - Chemicals, diluted acids and alkalis, drinking water. Additional abrasive applications like phosphoric acid with low concentration. FDA, USP and WRAS approved⁽¹⁾.

HT - Suitable for abrasive slurries containing hydrocarbons.

425 - Salts in water, acids and alkalis, ozone, water, intermittent steam. Great solution for on food and beverages applications. FDA and USP approved⁽¹⁾.

Rubber Diaphragm

237 - The best solution for sodium hypochlorite. Great with strong acids and low concentration chlorine gas. It is also oil resistant.

XA - Specifically design for both abrasive and corrosive application such as phosphoric acid, metal treatment and mining applications.

C - Lubricating oil, cutting oils, paraffin, animal vegetable oils and aviation kerosene at low temperatures.

AA - Excellent choice on abrasive applications such as slurries or dry powders. The diaphragm has a light brown colour, and is sulphur cured.

Type KB/K Diaphragm			
Diaphragm	Composition	Size	Temperature
226	Fluoroelastomer	1/2" to 12" DN 15 to DN300	-5°C to 120°C
425	Ethylene Propylene (EPM)	All Sizes	-40°C to 100°C
AA	Natural Rubber (Polyisoprene)	All Sizes	-40°C to 90°C
HT	Polychloroprene	All Sizes	-20°C to 90°C
237	Chlorosulphonated Polyethylene	All Sizes	-10°C to 100°C
300	Isobutylene Isoprene	All Sizes	-20°C to 100°C
C	Butadiene Acrylonitrile	All Sizes	-10°C to 90°C
XA	Ethylene Propylene Diene (EPDM)	All Sizes	-40°C to 100°C

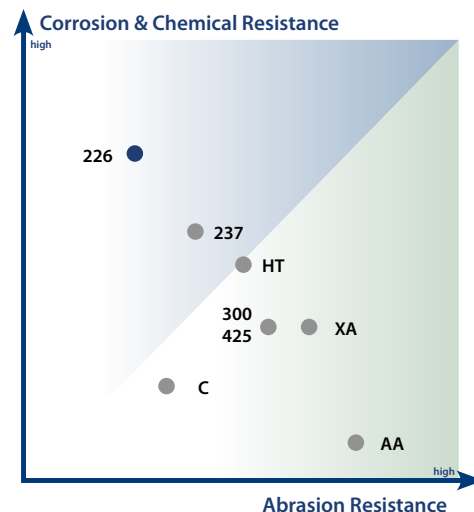

¹⁾ FDA - Food & Drug Association USP - United States Pharmacopeia

WRAS - Water Regulations Advisory Scheme

DIAPHRAGM VALVES TYPE KB/K TOP WORKS

Top Works

Standard Range

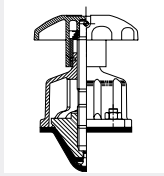

Standard Plastic Rising Handwheel with indicator
Valves sizes: DN15 to DN50
(1/2" to 2")

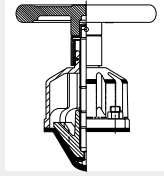

Metal Rising Handwheel with indicator
Valves sizes: DN15 to DN150
(1/2" to 2")

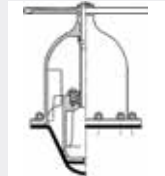

Standard Non-Rising Handwheel without indicator
Valves sizes: DN200 to DN350
(8" to 14")



Non-Rising Handwheel with indicator
Valves sizes: DN200 to DN350
(8" to 14")

High Performance

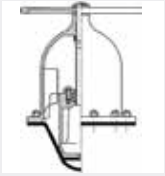

Non-Rising Handwheel (fluoroelastomer sealed)
Valves sizes: DN15 to DN300
(1/2" to 12")

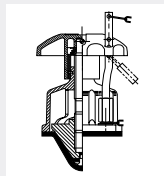

Rising Handwheel with indicator (simple padlocking)
Valves sizes: DN15 to DN150
(1/2" to 2")

Saunders Actuation



ESM/ES actuators (spring close/ spring open/double acting)
Valve sizes DN15 to DN250
(1/2" to 10")

For more details on actuation see pages 17-20

Manual Valves Working Pressure & Temperature

Maximum manual working pressures for KB Type Saunders Diaphragm valve. For ES actuators, please refer to appropriate actuator performance selection technical data sheets.

Size (DN)	Pressure (bar)	
	Rising handwheel	Non-Rising handwheel
15	10	-
20	10	-
25	10	-
32	10	-
40	10	-
50	10	-
65	10	-
80	10	-
100	10	-
125	6	-
150	6	-
200	-	3.5
250	-	3.5
300	-	3.5
350	-	1.5

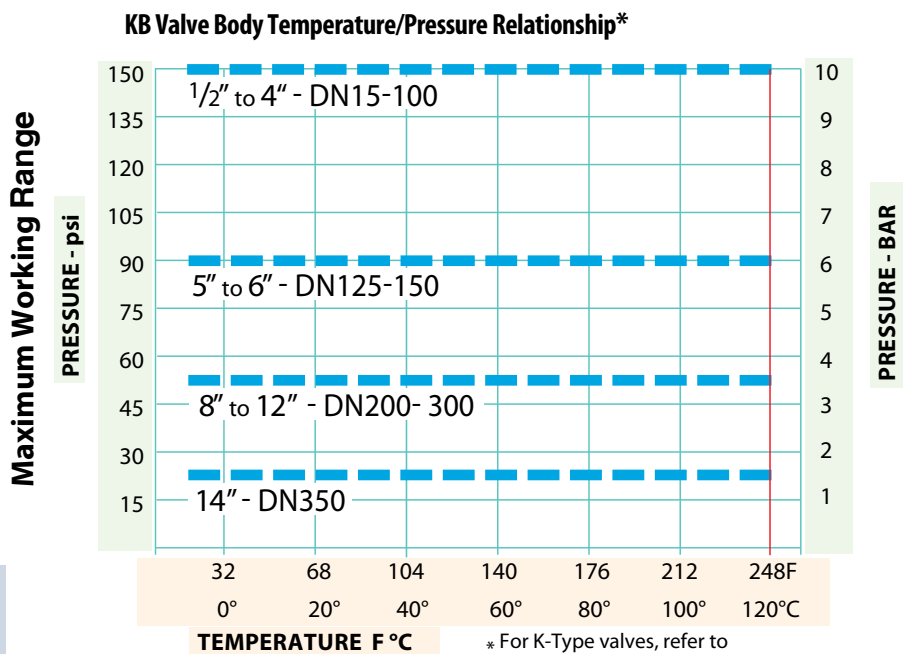

All Saunders valves are pressure tested in accordance with BS EN12266-1 standard.

- Shell test: 1.5 times max rating working pressure
- Seat test: 1.1 times max rating working pressure

DIAPHRAGM VALVES ACTUATION

Original Saunders ES Modular Design

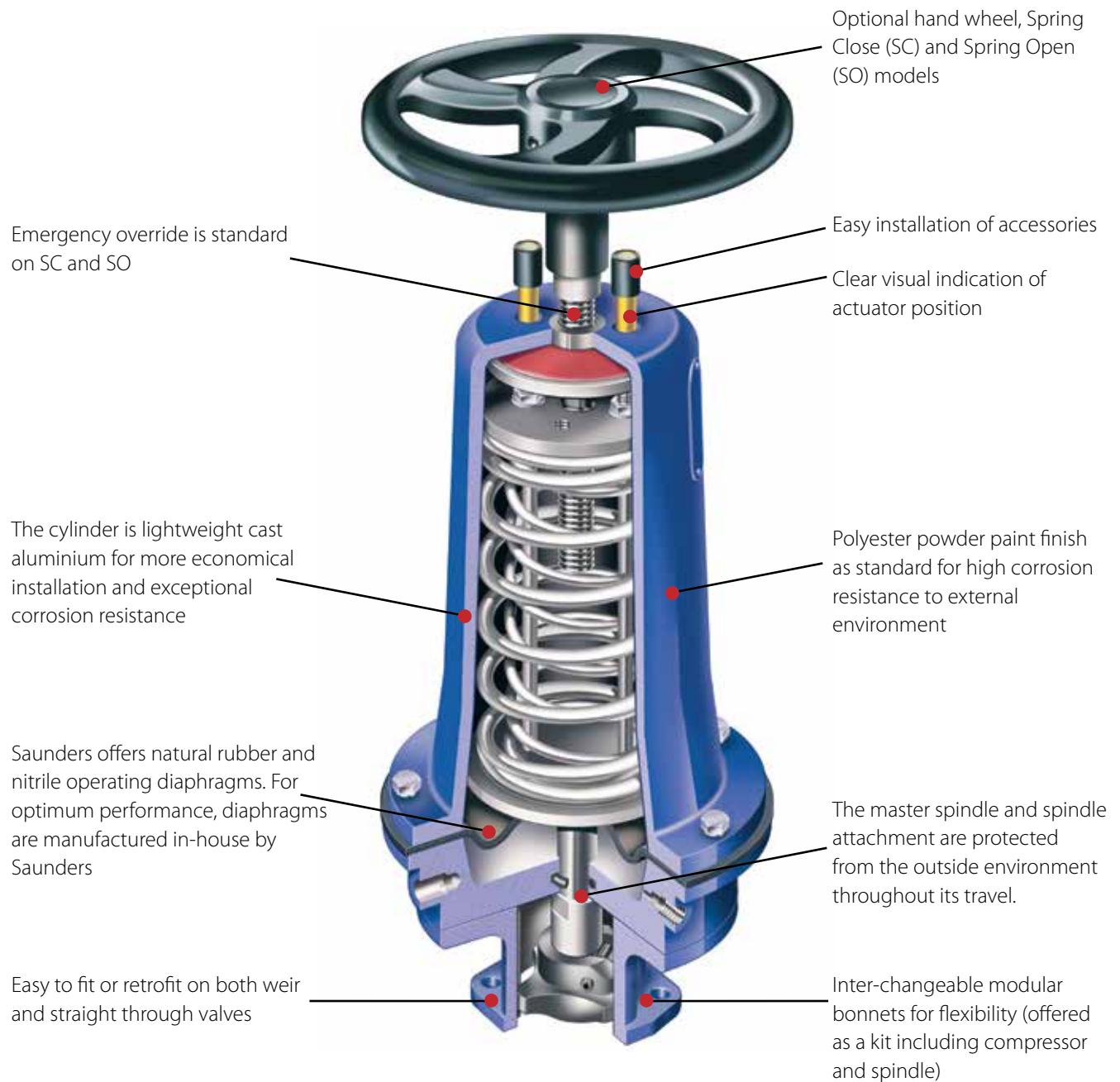

Wide range of actuators that provide reliable remote control

DIAPHRAGM VALVES ACTUATION

Saunders Actuators - Model Range and Options

When manual operation is inadequate or inconvenient, Saunders offer a variety of actuators covering valve sizes up to DN250, for different line and operating pressure options. We offer three different actuators, designed for various characteristic performances.

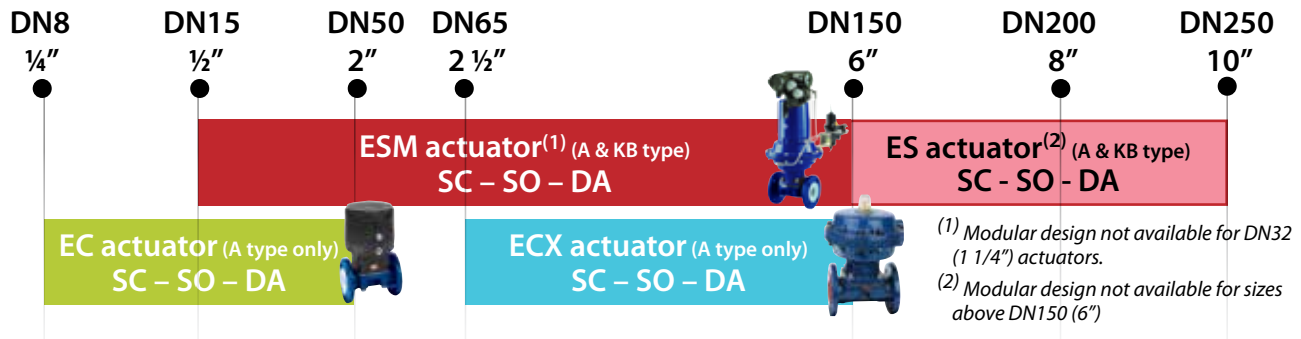

Modes of Operation		
Failsafe Closing	Failsafe Opening	Double Acting
Failsafe closing actuators close the valve against line pressure in the event of failure (or intended shutoff) of operating pressure to the actuator.	Failsafe opening actuators open the valve to allow line fluid to flow in the event of failure (or intended shutoff) of operating pressure to the actuator.	Operating pressure opens and closes the valve.
Normal Use: When valve is usually in the closed position (to avoid using a constant supply of operating pressure).	Normal Use: When valve is usually in the open position (to avoid using a constant supply of operating pressure).	Normal Use: When a failsafe mode is undesirable.

Key Features ES Modular Actuator	Key Features EC Actuator	Key Features ECX Actuator
<ol style="list-style-type: none"> Modular design for flexibility Adjustable spring tension to optimize closure force and maximizes diaphragm life Full range of accessories Light weight Silicon Aluminium housings Polyester coating for environmental protection 	<ol style="list-style-type: none"> Compact piston style actuators Versatile and robust design Composite material Temperature range of -10° to 100°C ambient (autoclave maximum 150°C) Spring packs to suit pressure requirements. 	<ol style="list-style-type: none"> Compact extension to the EC size range Comprehensive spring packs for a wide range of pressure Full range of accessories Light weight Silicon Aluminium housings Polyester coating for environmental protection

DIAPHRAGM VALVES ACCESSORIES & FITTINGS

Saunders Actuators - Materials & Accessories

Dimensions (mm)								
Model	Size Range	Valve type	Material	Solenoid	Switchbox	Positioner	Air Filter	Handwheel
ES	DN15-DN250 1/2" - 10"	A, KB	SiAl ⁽¹⁾	✓	✓	✓	✓	✓
EC	DN8-DN50 1/4" - 2"	A	PES ⁽²⁾	✓	✓	✓	✗	✗
ECX	DN65-DN150 2 1/2" - 6"	A	SiAl ⁽¹⁾	✓	✓	✗	✓	✗

⁽¹⁾ SiAl – Silicon-Aluminium ⁽²⁾ PES – polyethersulphone ✓ Available ✗ Unavailable



007 Switchbox

Modular switch-boxes are available for the ES Modular actuator range. Offering a wide range of both mechanical and proximity switches as well as other options, i.e. ASi-interface.



ES Positioner

Provides precise control of the flow through the valve. This long life corrosion resistant range suits a wide variety of applications with reliability and accuracy. Available as pneumatic electro-pneumatic intrinsically safe and explosion proof, together with a variety of feedback options. A digital option is also available.

Shown mounted to ESM Actuator

Opti-SET

- Self setting. Minimize validation/set-up time.
- Remote, open/closed indication.
- Economical, compact, lightweight design.
- Allows for compression/set of the diaphragm.
- Easy access, even at difficult angles.
- Available with mechanical or proximity switches, including safety options.



Mini Positioner

For control application on the EC actuated valve, Saunders offers both pneumatic, electropneumatic and digital inputs with sensor feedback option and linear mounting design providing a compact control solution.



Saunders® I-VUE

The Saunders® I-VUE is a compact intelligent valve sensor that provides accurate and reliable valve position feedback. It is suitable for EC or ECX actuated valves. Key **Features and Benefits:**

- Available as Point-to-Point or with network capabilities (ASi & DeviceNet)
- Highly accurate electronic sensing technology to continuously monitor valve position.
- Self Setting (without entry) feature that facilitates setting and programming of switch without opening the enclosure.



MODULE Switchbox

This module switchbox option is available for EC & ECX actuator ranges. The switchbox offers a wide range of mechanical and proximity sensors with space for up to 4 switches, integral solenoid valve & ASi interface*.

*ASi Interface can be retrofitted.



Solenoid valves

A wide range of locally mounted banjo solenoid valves can be fitted to the Saunders actuator range with a manual override option and various hazardous area classifications. The solenoid range is designed to cover all requirements.



Other control options available upon request.
Please, contact Saunders for more information

CRANE ChemPharma & Energy

CRANE Process Flow Technologies Ltd.

Grange Road

Cwmbran, Gwent NP44 3XX

UNITED KINGDOM

Tel: +44 1633 486666

Fax: +44 1633 486777

www.cranecpe.com

CRANE[®]

CRANE Process Flow Technologies
 SPRL / BV
 Avenue Franklin No. 1
 Wavre, B-1300, Belgium
 Tel: +32 10 8184 44
 Fax: +32 10 8184 58

CRANE ChemPharma & Energy
 Headquarters
 4444 Cooper Road
 Cincinnati, Ohio 45242
 Tel: 513-745-6000
 Fax: 513-745-6086

CRANE Process Flow Technologies (India) Ltd
 Solitaire, 5th & 6th Floor, S.No. 131 / 1+2,
 ITI Road, Aundh, Pune - 411007, India
 Tel: +91 20 3056 7800
 Fax: +91 20 3056 7812

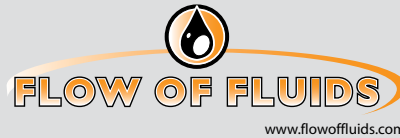

brands you trust.



CP_EG-SAUNDERS IDV SML-BU-EN-A2-06-2013-12

Crane Co., and its subsidiaries cannot accept responsibility for possible errors in catalogues, brochures, other printed materials, and website information. Crane Co. reserves the right to alter its products without notice, including products already on order provided that such alteration can be made without changes being necessary in specifications already agreed. All trademarks in this material are property of the Crane Co. or its subsidiaries. The Crane and Crane brands logotype, in alphabetical order, (ALOYCO[®], CENTER LINE[®], COMPAC-NOZ[®], CRANE[®], DEPA[®] & ELRO[®], DUO-CHEK[®], FLOWSEAL[®], JENKINS[®], KROMBACH[®], NOZ-CHEK[®], PACIFIC[®], RESISTOFLEX[®], REVO[®], SAUNDERS[®], STOCKHAM[®], TRIANGLE[®], UNI-CHEK[®], VALVES[®], WTA[®], and XOMOX[®]) are registered trademarks of Crane Co. All rights reserved.